

# S15

## Speicherstein



Abbildung: S15 (Grundmodell)  
Oberflächenveredelung:  
Camina Sichtbetonoptik

Abbildung: S15 in Kombination mit Designbeton  
Oberflächenveredelung: Camina Sichtbetonoptik



### Standard



### Gesamtgewicht



### Kamineinsatz

Ekko U 55(45)51 h  
NW-Leistung: 9 kW  
Abgasstutzen: Ø 200 mm



Mehr Infos unter  
[camina-schmid.de](http://camina-schmid.de)

### Optional



### Zubehör



### Speicherbeton



Speicherbeton



Designbeton

## Frontansicht M 1:20

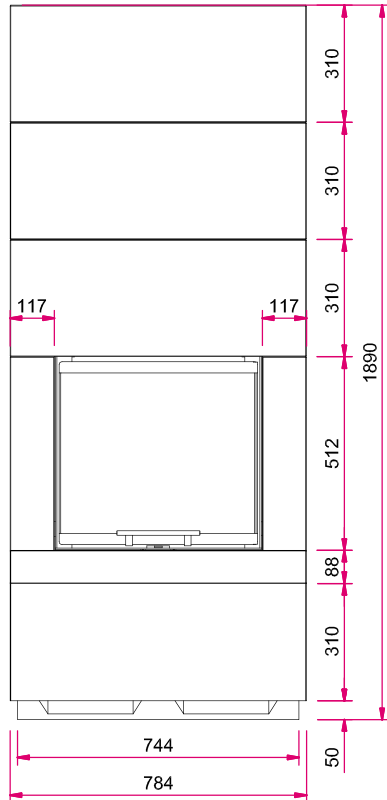

## Seitenansicht links M 1:20

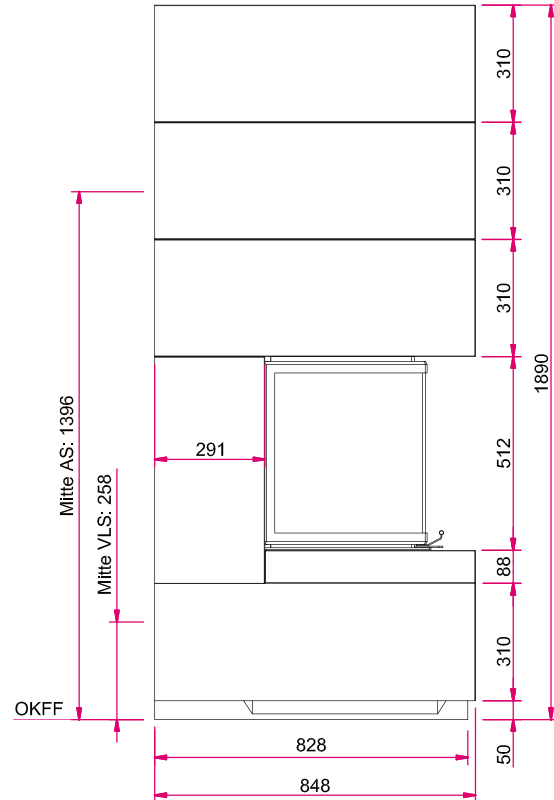

Hinweis: Mit **optionalem Zubehör** bitte die Angaben in den Preislisten beachten.  
AS: Abgasstutzen, VLS: Verbrennungsluftstutzen, OKFF: Oberkante Fertigfußboden

## Draufsicht M 1:20

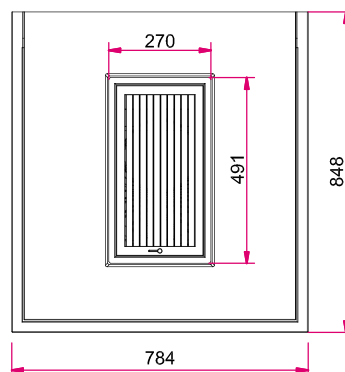

# S15 mit Naturstein-Feuertisch Speicherstein



Abbildung: S15 mit Naturstein-Feuertisch Nero  
Oberflächenveredelung: Camina Silikatanstrich



## Standard



Tür  
hochschiebbar



Front  
Anthrazit

Gesamtgewicht



ca.  
625 kg

## Kamineinsatz

Ekko U 55(45)51 h  
NW-Leistung: 9 kW  
Abgasutzen: Ø 200 mm



A

Mehr Infos unter  
[camina-schmid.de](http://camina-schmid.de)

## Optional



Front veredelt



Front veredelt  
(komplett)

## Zubehör



SMR



Vorlegeplatte

## Naturstein und Speicherbeton

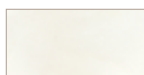

Estremos



Grigio



Jade



Marone



Mocca Creme



Nero



Nero matt



Sabbia



Speicherbeton

# Maßzeichnungen S15 mit Naturstein-Feuertisch

Frontansicht M 1:20

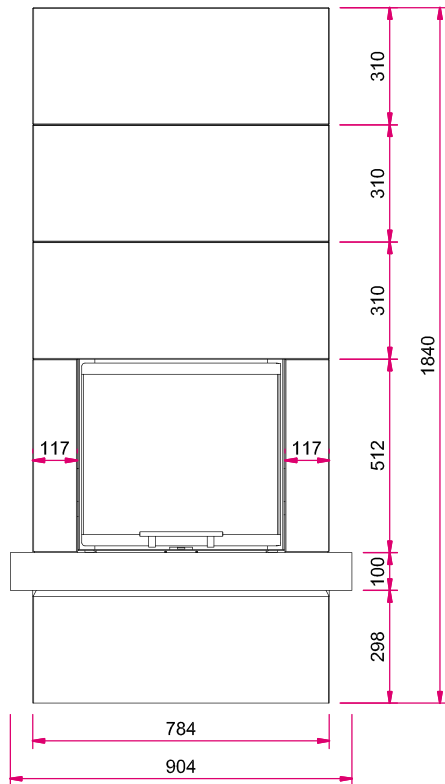

Seitenansicht links M 1:20

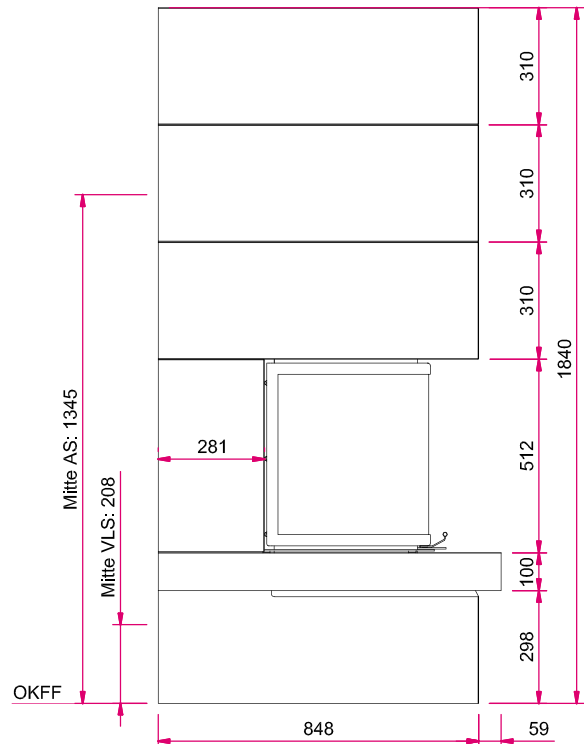

Hinweis: Mit optionalem Zubehör bitte die Angaben in den Preislisten beachten.  
AS: Abgasstutzen, VLS: Verbrennungsluftstutzen, OKFF: Oberkante Fertigfußboden

Draufsicht M 1:20

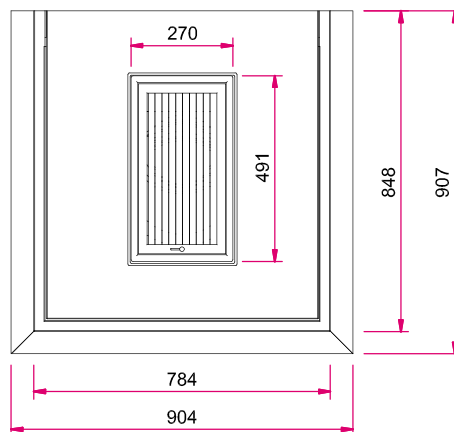

# S15 mit Naturstein-Bank (mit Überstand) Speicherstein

**Camina**  
EXCLUSIVE FIREDESIGN



Abbildung: S15 (Grundmodell)  
Oberflächenveredelung:  
Camina Sichtbetonoptik

Abbildung: S15 mit Naturstein-Bank Grigio (mit Überstand)  
Oberflächenveredelung: Camina Sichtbetonoptik



## Standard



Tür  
hochschiebbar



Front  
Anthrazit

## Gesamtgewicht



ca.  
625 kg

## Kamineinsatz

Ekko U 55(45)51 h  
NW-Leistung: 9 kW  
Abgasutzen: Ø 200 mm



A

Mehr Infos unter  
[camina-schmid.de](http://camina-schmid.de)

## Optional



Front veredelt



Front veredelt  
(komplett)

## Zubehör



SMR



Vorlegeplatte

## Naturstein und Speicherbeton

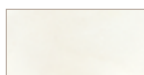

Estremos



Grigio



Jade



Marone



Mocca Creme



Nero



Nero matt



Sabbia



Speicherbeton

# Maßzeichnungen S15 mit Naturstein-Bank (mit Überstand)

Frontansicht M 1:20

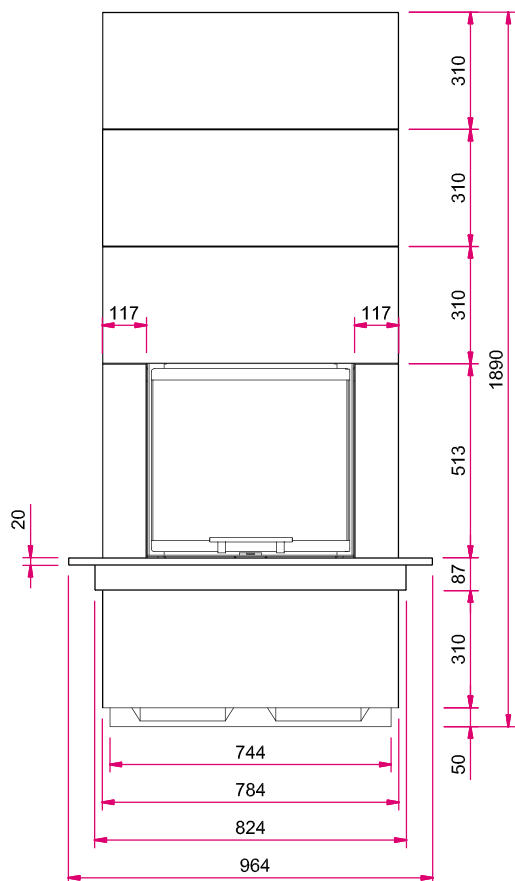

Seitenansicht links M 1:20

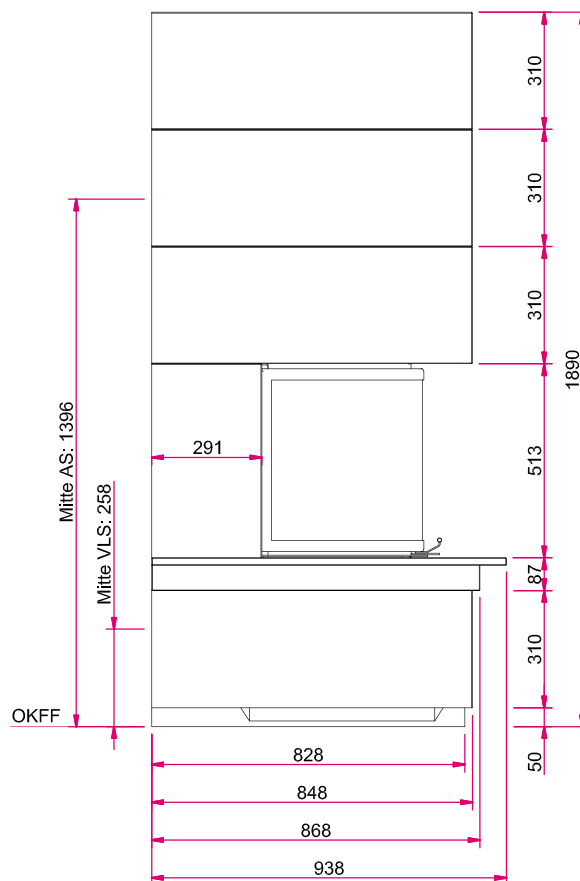

Hinweis: Mit optionalem Zubehör bitte die Angaben in den Preislisten beachten.  
AS: Abgasstutzen, VLS: Verbrennungsluftstutzen, OKFF: Oberkante Fertigfußboden

Draufsicht M 1:20

